

Mitutoyo

Mitutoyo Quality

CNC Coordinate Measuring Machine CRYSTA-Apex V Series

Coordinate Measuring Machines



Bulletin No. 2297

Go above and beyond.

CRYSTA - Apex *V* SERIES

500/700/900 Series

Introducing our new CNC coordinate measuring machine focused on accuracy, speed, and versatility.

We are proud to unveil our CRYSTA-Apex V Series, which delivers faster measurements without compromising the measuring machine's inherent accuracy. It also supports measurement of workpieces of many different shapes, including impellers and blades. The CRYSTA-Apex V Series is a new generation CNC coordinate measuring machine that helps make the smart factory—a factory that leverages IoT for the advanced management of production and quality information—a reality.



A brand new design that conveys cutting-edge capabilities and creativity.

An extensive product lineup that covers a wide range of measurements, from small to mid-sized workpieces.

The new CRYSTA-Apex V series design distinguishes this generation of Smart Measuring Systems (SMS), from the previous model that includes cutting edge IoT* capabilities for this precision measuring instrument.

With a lineup of three width sizes / ten models covering measurements of small to mid-sized workpieces, the CRYSTA-Apex V Series delivers further advances in accuracy, performance, speed, and versatility.

*Internet of Things



CRYSTA-Apex V 544

Measuring ranges (2 sizes)

X: 500 mm

Y: 400, 700 mm

Z: 400 mm





SMS (Smart Measuring System)

This system allows on-line monitoring of the operational status of a measuring machine and visualization of measurement data produced during the manufacturing process to enable product quality improvement.



CRYSTA-Apex V 776

Measuring ranges (2 sizes)

- X:** 700 mm
- Y:** 700, 1000 mm
- Z:** 600 mm

CRYSTA-Apex V 9106

Measuring ranges (6 sizes)

- X:** 900 mm
- Y:** 1000, 1600, 2000, mm
- Z:** 600, 800 mm

Note: All models incorporate a main unit Startup system (relocation detection system), which disables operation when an unexpected vibration is applied or the machine is relocated. Be sure to contact your nearest Mitutoyo Sales Office prior to relocating this machine after initial installation.

HIGH PRECISION



Absolute quality

Provides accuracy that is unmatched by any previous general-purpose measuring machine through features that include the following: a real-time temperature compensation system that greatly contributes to measurement accuracy; a maximum permissible length measurement error of $1.7\ \mu\text{m}$ (i.e. $2\ \mu\text{m}$ uncertainty for a measured length of 100 mm) guaranteeing high-accuracy measurements of the most intricate workpieces; and enhanced repeatability.

Real-time temperature compensation

In the past, the accuracy of CMMs could not be guaranteed unless they were installed in constant temperature rooms. The temperature compensation feature guarantees accuracy under temperature conditions of 16-26 °C. This feature measures the temperature of the workpiece and that of the measuring machine, calculates what the measurement value would be at 20 °C, and outputs this value as the measurement result.

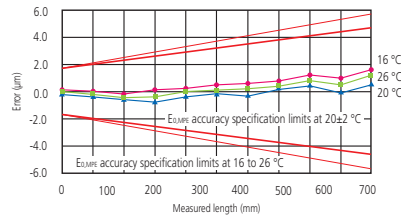

Graphs showing the effectiveness of temperature compensation

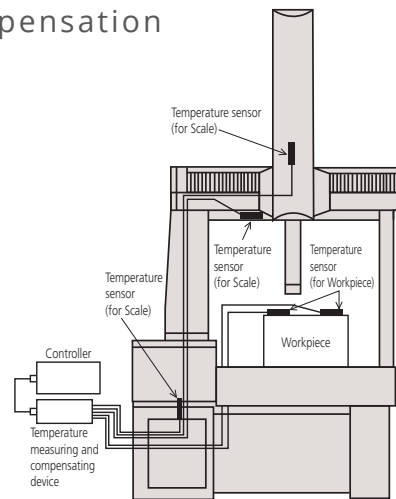

High accuracy in the 1.7 µm class

The CRYSTA-Apex V Series guarantees a maximum permissible length measurement error or $E_{0,MPE}$ of $1.7 + 3L/1000 \mu\text{m}$. Let's consider a CMM offering $E_{0,MPE}$ of approximately $2.5 + 4L/1000 \mu\text{m}$, which would generally be considered high-accuracy. If, for example, the required tolerance on a dimension is $\pm 0.02 \text{ mm}$, the uncertainty of this machine would exceed one-fifth of this value* ($\pm 0.004 \text{ mm}$, as shown on diagram at right) for any measured length over 375 mm. In contrast, with the V Series, the measurement uncertainty remains within one-fifth of the required tolerance for measuring lengths up to 766 mm. Although the difference in the first term accuracy specification between the two machines may seem small (a mere $0.8 \mu\text{m}$), the V Series actually offers guaranteed accuracy for more than double the measuring range.

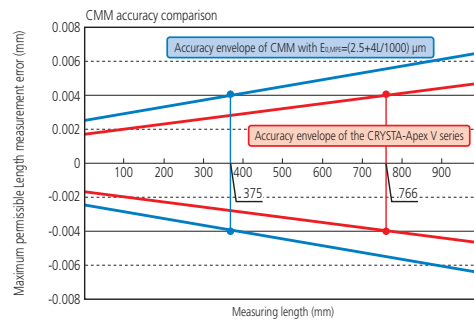

* Assuming an acceptable working ratio between component tolerance and accuracy of measurement is 5:1 minimum.

Repetitive accuracy

To eliminate causes of dynamic error and to deliver high repeatability, data from measurements using scanning probes are processed for stabilization. The probe is kept motionless for a few seconds when its tip first contacts the workpiece, thereby ensuring that causes of dynamic errors are eliminated as much as possible and making it possible to deliver highly accurate measurement results.



HIGH SPEED

Dramatically reduces measurement time with high-speed measurements for any shape

The V Series lets users freely set measurement paths along three-dimensional forms, enabling intricate workpieces to be measured along their curved surfaces and contours. It also allows for high-speed measurement unaffected by processing accuracy or misregistration through real-time correction of path errors caused by differences between the workpiece and design values. The V Series, with its high drive speed and acceleration combined with a maximum measuring speed (the speed with which the stylus traces over the workpiece) of 8 mm/s, dramatically reduces the total measuring time.



Speed and acceleration to reduce measurement time

The CRYSTA-Apex V Series offers a maximum drive speed of 519 mm/s and a maximum acceleration of 2,309 mm/s². The V Series with its high drive speed and acceleration combined with measuring speeds up to 120 mm/s, significantly reduces total measuring time. The greater the number of measurement requirements, the more time savings realized. This in turn results in a cost savings, increased inspection throughput, and more workpieces inspected thereby increasing the quality assurance.



High-speed optimal path scanning

The V Series is equipped with a measurement feature that allows users to specify scanning measurement paths (design values). This feature allows for high-speed, high-accuracy scanning by correcting dynamic errors that would otherwise be produced by acceleration and deceleration stresses. Measurement paths can be freely specified for three-dimensional forms as well, which enables intricate workpieces to be measured by tracking precisely along their curved surfaces and contours.



Active scanning feature

Enables high-speed measurement unaffected by processing accuracy or probe path control errors while maintaining the advantages of 3D optimal path scanning measurement, by limiting discrepancies between design values and the actual workpiece. The intricacy of some workpieces (e.g. turbine blades, fan blades, and impellers) causes their processing accuracy to fluctuate or makes them more susceptible to probe path control errors. Probe path control errors during measurement are often aborted. The V Series enables smooth measurement of such workpieces.

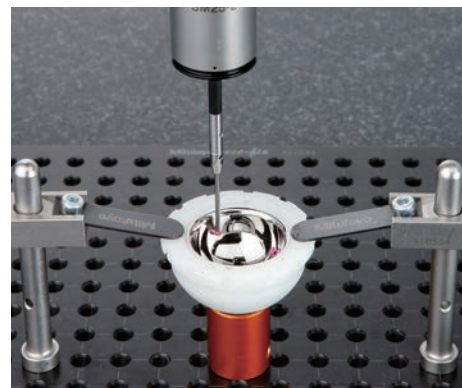

DIVERSITY

Enables highly accurate and highly efficient measurement of workpieces of practically any shape

Users can choose the optimal probe for their workpiece from our lineup of CMM probes—including scanning probes and non-contact probes—to conduct highly accurate and efficient measurement.



PH10MQ
RENISHAW
-90
-135
105
A
SurfaceMeasure
Mitutoyo
FLYING SPOT LASER PROBE
201FS

Probes for Coordinate Measuring Machines

Compact high-accuracy scanning probe SP25M

The SP25M is a compact, high-accuracy scanning probe with a 25-mm outside diameter. It is a multi-function CNC CMM probe that can collect data from not only scanning measurements (where SP25 moves while in contact with the workpiece collecting up to 10,000 points/sec) but from high-accuracy point measurements as well.

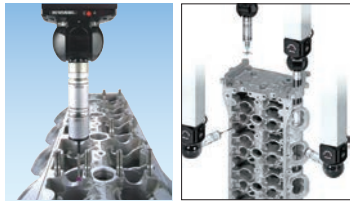

Non-contact laser probe SurfaceMeasure

SurfaceMeasure is a laser probe that collects coordinate values of the surface of the workpiece by moving and irradiating laser light over the workpiece. It can quickly obtain massive amounts of 3D surface data.

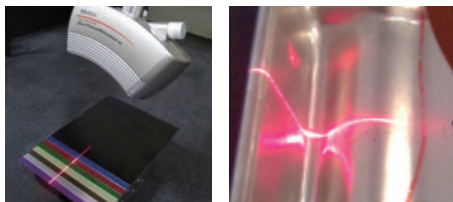

Measuring color sample boards

Measuring glossy workpieces



Automatic probe changer ACR3

Necessary when using probes that do not support automatic stylus exchange for fully automated measurements that require changes in stylus diameter and/or length. Also necessary for fully automated measurements that require switching between contact and non-contact probes. Now with a simpler structure and increased durability, as a result of a new mechanism that uses the drive of the CNC CMM for automatic exchange.



Unlock

Lock

Enables efficient, high-accuracy measurements of a wide variety of workpieces

We have many applications for the CRYSTA-Apex V Series, such as scanning probes and non-contact probes, that enable measurement of a wide range of workpieces.

Separator molds

Electric vehicle

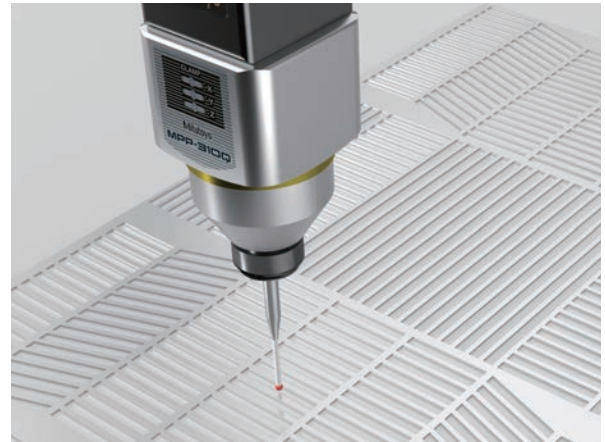

Surface and cross-section measurements of precision molds for separators can be conducted using a low measuring force, high-accuracy scanning probe. Three-dimensional error analysis and cross-sectional form analysis may be performed based on the obtained measurement points.

Impeller

Automobile



Impellers can be measured using a highly robust non-contact laser probe that reduces multiple reflections. Just as accurate as contact probes, this probe offers high geometric reproducibility.

Motor cores

Electric vehicle

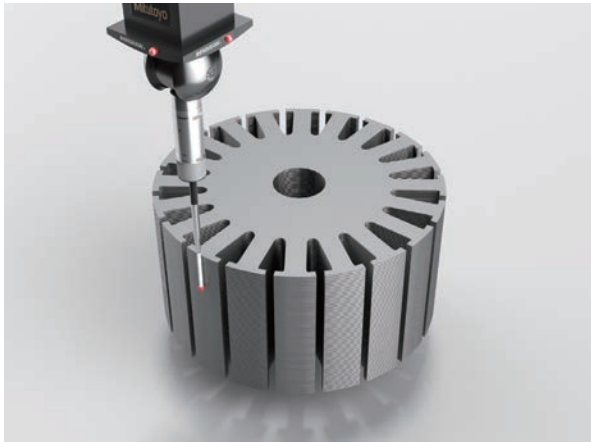

The V Series can measure the straightness, cross-sectional form, etc. of laminated motor cores. It can also conduct measurements of three-dimensional structures, including measurements of side faces and dimensions at arbitrary heights.

Blade

Aircraft



The cross-section of an aircraft engine turbine blade can be measured using a compact, high-accuracy scanning probe. Even workpieces susceptible to large errors, such as castings, can be measured quickly and reliably.

Artificial joint

Medical care



Freeform surface measurement of prosthetic joints can be conducted using a compact, high-accuracy scanning probe. Three dimensional error analysis may be performed based on the obtained measurement points.

Transmission cases

Power trains



Non-contact laser probes require dramatically less measurement time compared to contact (scanning) probes. Scanning at once from three directions enables simultaneous measurement of the top and side faces, which means less repositioning and efficient measurement of even the most intricate workpieces.

SOFTWARE

Application software that offers both functionality and operability

We offer an extensive lineup of application software for generating measurement programs automatically, conducting gear analysis, and performing evaluations using CAD. From simple to complex measurements, they can resolve any measurement issues that our customers may encounter.

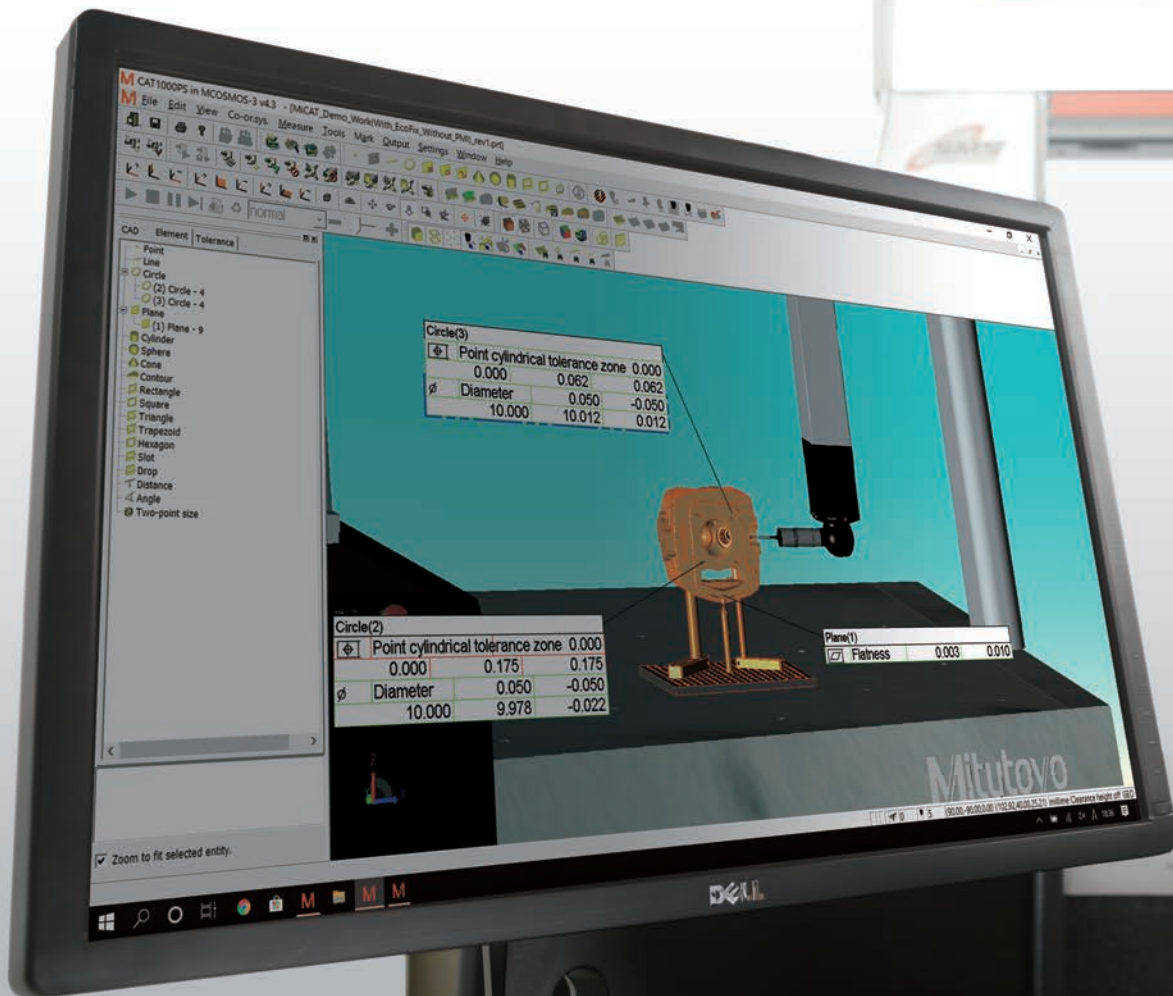



MCOSMOS

<Data Processing System for CMMs>

MCOSMOS is a family of Windows-based processing programs for CMMs. It includes an extensive lineup of optional software applications that support a wide range of probes, enabling fully automated measurement of all kinds of workpiece.

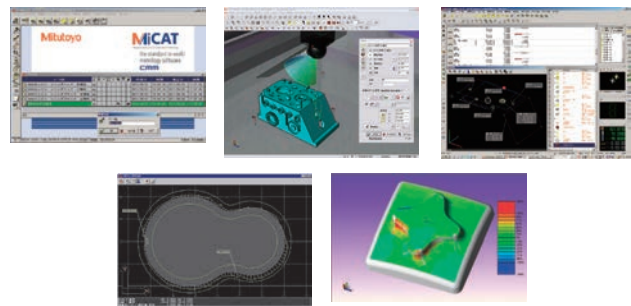

MiCAT Planner

<Automatic Measurement Program Generation Software>

Software automatically generates measurement programs by reading tolerance information added to 3D CAD models to determine which part of the workpiece should be measured. Compared to conventional methods (teaching), this method can create measurement programs more efficiently.

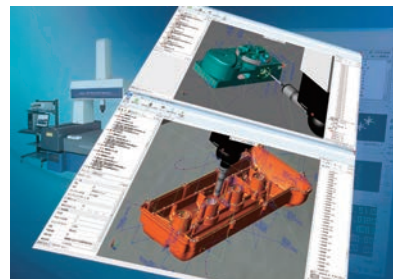

MSURF

<Non-contact Laser Measurement and Evaluation Program>

MSURF is a package program comprised of MSURF-S for scanning and MSURF-I for inspection. Its functions include comparing and checking measurement point data (obtained using MSURF-S) against master model data, and measuring dimensions (MSURF-I).

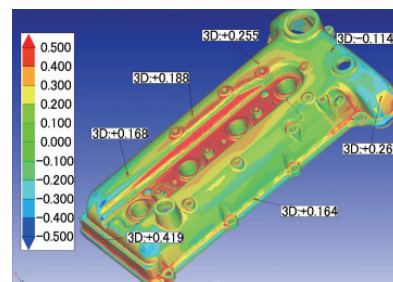

SMART FACTORY

From status management to preventive maintenance. Kickstart your smart factory through visualization.

Mitutoyo has developed new features that use a network to centrally manage manufacturing process information.

MeasurLink predicts defects by collecting and analyzing measuring machine data in real time. The Status Monitor (Smart Measuring System, or SMS), which indicates the operational status of the measuring machine, and the Condition Monitor, which indicates the condition of the machine itself, help maintain measurement accuracy, increase productivity, and improve maintenance management.



Status Monitor

Can remotely monitor measuring machines

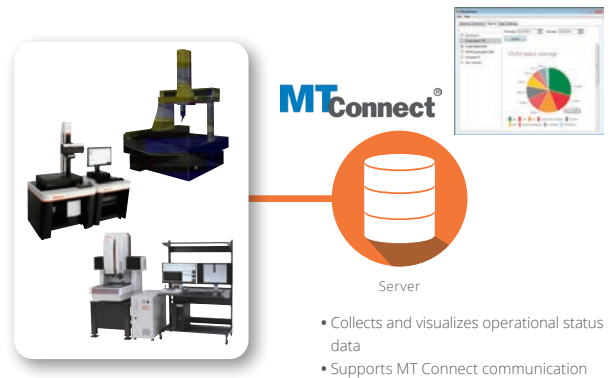



Condition Monitor

Conduct preventive maintenance through monitoring

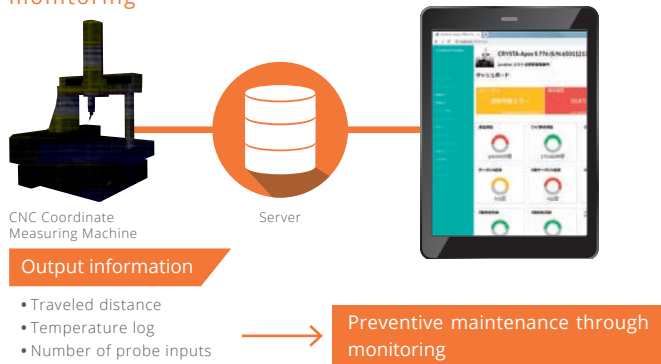

MeasurLink

Reduces defective products by visualizing quality

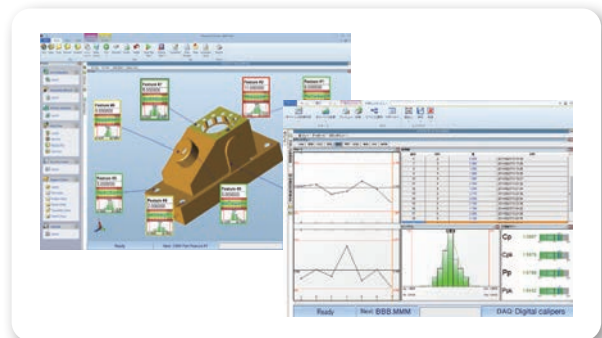

USABILITY

Effectively reduces operation and measurement time through enhanced convenience and usability

Equipped with the Quick Launcher, which improves operability, and a joystick box includes precision control and functions to facilitate measuring intricate workpieces with speed and ease. Such enhancements in usability work to streamline the workflow by reducing measurement time.

Part program execution

Equipped Parts program execution is equipped standard with the Quick Launcher, which enables simple and intuitive operation for easy execution. The touch panel monitor improves operability, making operations effortless for anyone. Part programs can also be executed via barcodes and QR codes.



Joystick box

The joystick box allows users to easily operate their CRYSTA-Apex V Series CMM. It comes with control buttons marked with user-friendly icons and an override knob for changing speed.



MiCAT Planner

Software automatically generates measurement programs by reading tolerance information added to 3D CAD models to determine which part of the workpiece should be measured. Compared to conventional methods (teaching), this method can create measurement programs more efficiently.

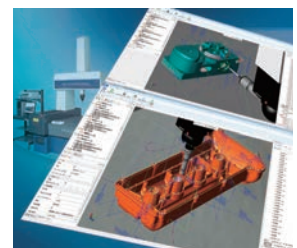

OPTIONS

Supports fully automated measurements and efficient setting to broaden options for applied measurements

Supports fully automated measurements that capitalize on the advantages of CNC CMMs.

Also supports efficient setting to broaden options for applied measurements by, for example, providing clamping tools that enable users to fix various workpieces more easier.

Automation example

The V Series' ability to deliver high-accuracy measurements across a wide temperature range eliminates the need for a dedicated measuring room. This allows for the automation of in-line and line-side measurements within the manufacturing process (i.e. on the manufacturing line), which significantly reduces measurement time and streamlines the workflow.



Clamping system Eco-Fix Kit

Mitutoyo clamping tools comprised of a clamping system where elements can easily and quickly be assembled to affix various workpieces.



Rotary table

Optional measuring device for CNC CMMs developed for efficient and high-accuracy measurement of mainly rotary workpieces (gears, impellers, screw rotors, cylindrical cams, etc.). Can be used together with a scanning probe for synchronized scanning measurement, enabling a wide range of contour measurements broadening the range of applied measurements.

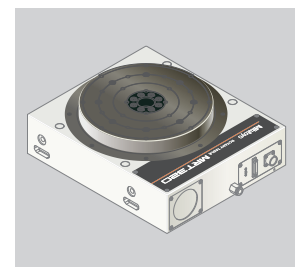

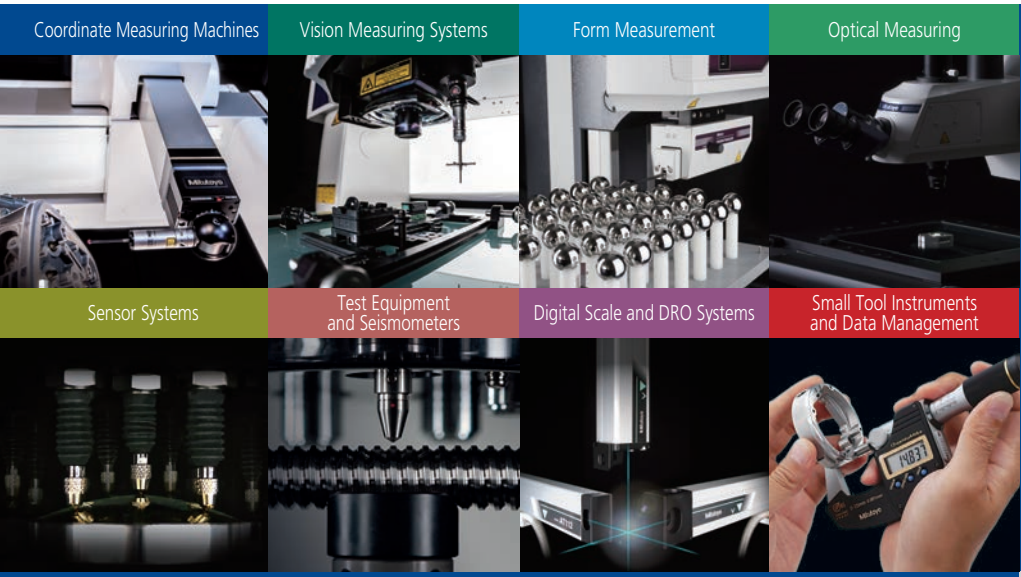

Whatever your challenges are, Mitutoyo supports you from start to finish.

Mitutoyo is not only a manufacturer of top quality measuring products but one that also offers qualified support for the lifetime of the equipment, backed by comprehensive services that ensure your staff can make the very best use of the investment.

Apart from the basics of calibration and repair, Mitutoyo offers product and metrology training, as well as IT support for the sophisticated software used in modern measuring technology. We can also design, build, test and deliver measuring solutions and even, if deemed cost-effective, take your critical measurement challenges in-house on a sub-contract basis.



Find additional product literature and our product catalog

www.mitutoyo.com

Note: All information regarding our products, and in particular the illustrations, drawings, dimensional and performance data contained in this printed matter as well as other technical data are to be regarded as approximate average values. We therefore reserve the right to make changes to the corresponding designs. The stated standards, similar technical regulations, descriptions and illustrations of the products were valid at the time of printing. In addition, the latest applicable version of our General Trading Conditions will apply. Only quotations submitted by ourselves may be regarded as definitive. Specifications are subject to change without notice.

Mitutoyo products are subject to US Export Administration Regulations (EAR). Re-export or relocation of our products may require prior approval by an appropriate governing authority.

Trademarks and Registrations

Designations used by companies to distinguish their products are often claimed as trademarks. In all instances where Mitutoyo America Corporation is aware of a claim, the product names appear in initial capital or all capital letters. The appropriate companies should be contacted for more complete trademark and registration information.



Mitutoyo America Corporation
www.mitutoyo.com
 One Number to Serve You Better
 1-888-MITUTOYO (1-888-648-8869)

- M³ Solution Centers:**
- Aurora, Illinois (Headquarters)
 - Boston, Massachusetts
 - Charlotte, North Carolina
 - Cincinnati, Ohio
 - Detroit, Michigan
 - Los Angeles, California
 - Birmingham, Alabama
 - Seattle, Washington
 - Houston, Texas